

Article number: 20231B422NI

Description: E+G

Tube supports GN231-B42-22-NI

Measures

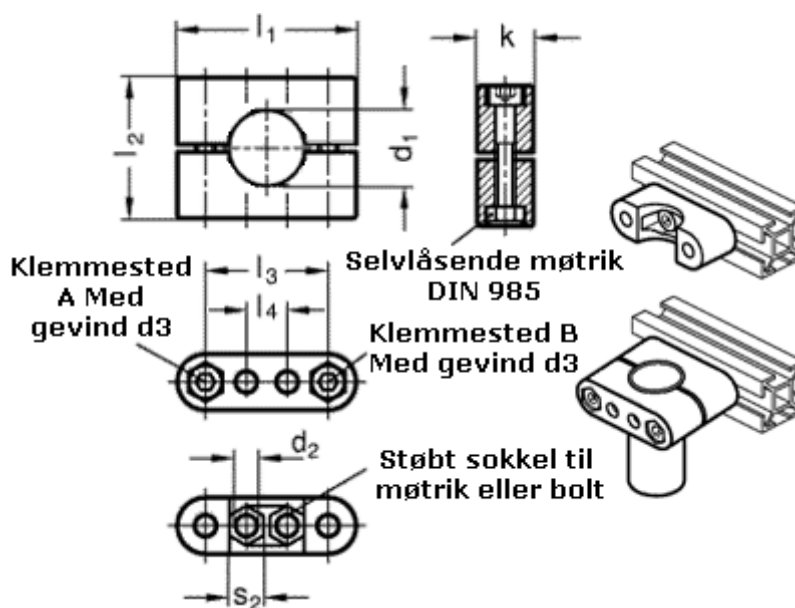

$d_1 = 42$

$s_2 = 17$

$d_2 = 11.0$

$d_3 = M10$

$k = 27$

$l_1 = 100$

$l_2 = 80$

$l_3 = 73$

$l_4 = 30$